



SERIES 16C

TEMPERATURE/PROCESS
CONTROLLER



*Instruction Manual
(Basic Operations)*

Introduction

Congratulations on your purchase of an Athena Series 16C Temperature/Process Controller. It is designed for ease of use and reliability wherever accurate control is required.

After following the instructions for installation, simply step through and set your operating parameters using the controller's easy menu system. The instrument may then be automatically or manually tuned to your process for optimum setpoint control.

A Quick Setup Reference Card is on page 5 and also attached as a tear-off card to the back of the instruction manual for experienced users of PID controllers.

As you look through this manual, you will notice blue italicized text appearing in the margins and adjacent to operating information. These notes impart important information about the controller and may answer questions you may have about its setup or operation. If you still have questions or require any assistance, please contact your Athena representative or call technical support at 1-800-782-6776. Outside the USA, please call 610-828-2490.

Precautions

After unpacking, inspect the instrument for any physical damage that may have occurred in shipping. Save all packing materials and report any damage to the carrier immediately.

Features

Field-Selectable Thermocouple, RTD, Current or Voltage Input
On/Off Through Full PID Operation

Autotuning - Heat or Cool

Eight-Segment Ramp/Soak

On/Off Output with Adjustable Hysteresis and Deadband

Dual Output Capability

Field-Configurable Process or Deviation Alarms

Bumpless, Auto-Manual Transfer

NEMA 4X Front Panel, "Watertight"

Dual 4-Digit (0.36"), 7-Segment Alphanumeric Display

Selectable Ramp to Setpoint

Alarm Inhibit

Loop Break Alarm Capability

Available Options Include Serial Communications, Contact/Digital Input, Remote Analog Setpoint, Transducer Excitation, Auxiliary Output, Dual Alarms, or Electromechanical Relay Alarm.

Approvals: UL, cUL, CE

Safety Warning



In addition to presenting a potential fire hazard, high voltage and high temperature can damage equipment and cause severe injury or death. When installing or using this instrument, follow all instructions carefully and use approved safety controls. Electrical connections and wiring should be performed only by suitably trained personnel.

Do not locate this instrument where it is subject to excessive shock, vibration, dirt, moisture, oil, or other liquids. The safe operating temperature range for this unit is 32°F to 140°F (0°C to 60°C).

This unit has been tested and found to be compliant with “NEMA Type 4X Enclosure - For Indoor Use Only.” When properly installed, this controller will maintain the integrity of a NEMA enclosure and remain “Watertight.” This rating is only applicable when the controller is properly installed into a suitably rated NEMA Type 4X housing.



Table of Contents

For information and operating instructions related to installed options and digital communications, refer to the Series C Options and Digital Communications manual supplied with your controller.

Installation	1
Dimensions and Mounting	2
Wiring	3
Output Types	5
Operation	6
Front Panel Controls	6
Power On	7
Security Levels	8
Operating Modes	9
Menu System Overview	10
Initial Setup Sequence	12
Parameter/Menu Descriptions	14
Input Menu	15
Temperature Input	16
Process (Linear) Input	16
Display Menu	17
Output Menu	17
PID Output and Control Menus	18
On/Off Output and Control Menus	19
Alarm Outputs	20
Autotune Damping	22
Ramp and Soak Menu	23
Supervisor Menu	24
Calibration Menu	25
Options Menu	25
AutoTuning	26
Manual Tuning	28
Error Codes	29
Technical Specifications	30
Ordering Codes	32
Recalibration Procedures	33
Quick-Helps	34
Warranty/Repairs	36
Glossary	39

Installation

Measurements between centerlines of panel cut-outs are the minimum recommended.

Unpacking and Inspection

1. Inspect shipping carton for obvious signs of mishandling.
2. After removing the controller from the shipping carton, inspect it carefully for damage. Never attempt to install and use a damaged unit.
3. Verify that the ordering code number indicated on the side of the controller matches what was ordered.

Figure 1.
Recommended Panel Layout for Multiple Controllers

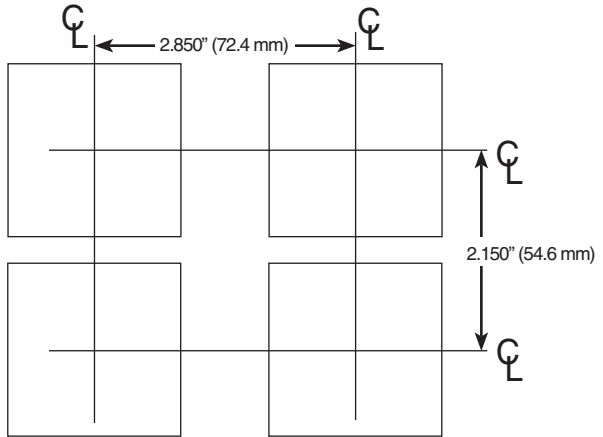

Dimensions

Figure 2. Case Dimensions

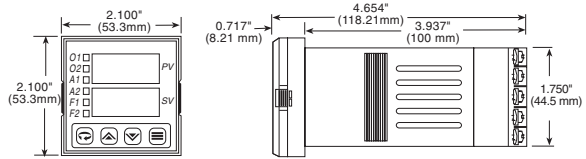

Prior to mounting the Series C in your panel, make sure that the cutout opening is of the right size, 1.771" x 1.771" (45 mm x 45 mm), and deburred to enable a smooth fit. A minimum of 4" (100 mm) of depth behind the panel is required.

Mounting

When properly installed through a NEMA enclosure, the integrity of the enclosure will be maintained and will remain "Watertight."

Figure 3. Series C Mechanical Components

Insert the Series C through the front panel cutout and slide the mounting collar back onto the unit from behind the panel. Push the mounting collar up tight to the back of the mounting panel.

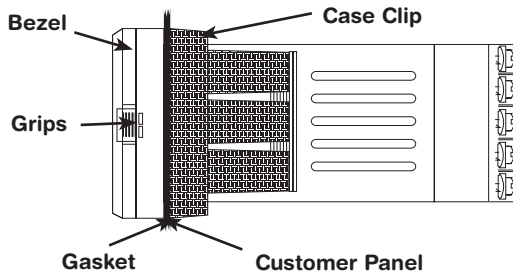

Wiring



IMPORTANT: All electrical wiring connections should be made only by trained personnel, and in strict accordance with the National Electrical Code and local regulations.

The Series C controller has built-in circuitry to reduce the effects of electrical noise (RFI) from various sources. However, power and signal wires should always be kept separate. We recommend separating connecting wires into bundles: power; signal; alarms; and outputs. These bundles should then be routed through individual conduits. Shielded sensor cables should always be terminated at one end only.

If additional RFI attenuation is required, noise suppression devices such as an R.C. snubber at the external noise source may be used. If you wish, you may order this suppressor directly from Athena, part number 235Z005U01.

Figure 4. Contact Identification

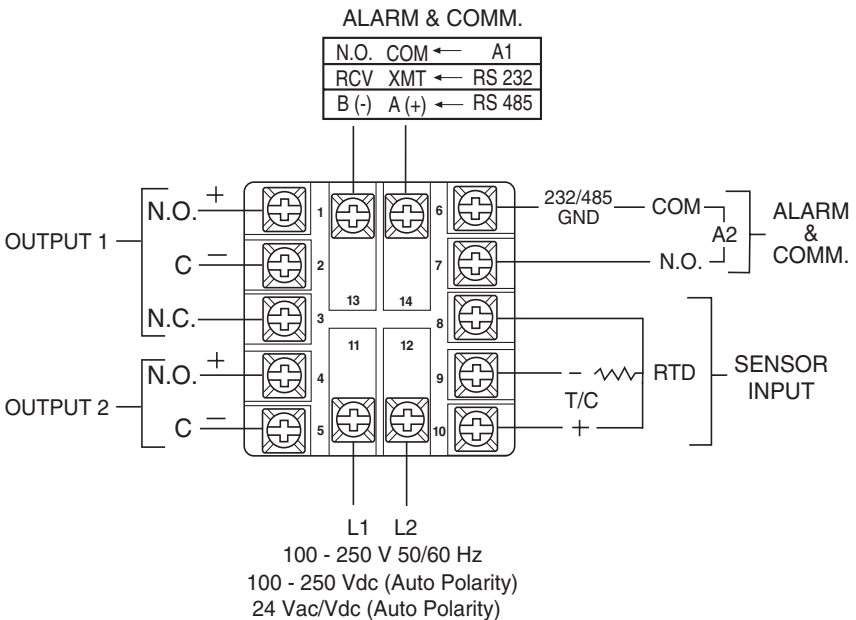

Wiring

Thermocouple circuit resistance should not exceed 100 ohms for rated accuracy; errors will occur at higher resistance values. If shielded thermocouple wire is used, terminate the shield only at one end.

Figure 5. Thermocouple Input Wiring

Make sure that you are using the appropriate thermocouple and extension wire. Connect the negative lead (generally colored red in ISA-type thermocouples) to contact #9; connect the positive lead to contact #10. Extension wires must be the same polarity as the thermocouple.

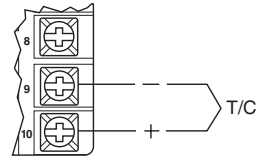
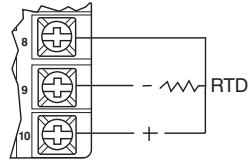

Figure 6. RTD Wiring

The Series C accepts input from 2- or 3-wire, 100 ohm platinum resistance temperature detectors (RTDs). Connect 2-wire RTDs to contacts #9 and #10, with a jumper across contacts #8 and #10. Keep leads short and use heavy gauge copper extension wire, if necessary, to minimize lead resistance. For long runs, 3-wire RTDs should be used.



Note: For 2-Wire RTD Jumper 8 & 10

Wiring



Figure 7. Process and Linear Input Wiring

Voltage Inputs: Connect the positive voltage input to contact #10; the negative input to contact #9.

Current Inputs: Connect the positive current input to contact #10; the negative input to contact #9.

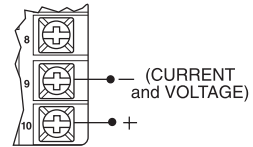

The Series C power supply accepts 100 to 250 Vac and 100 to 250 Vdc line power without any switch settings or polarity considerations. All connections should be made in accordance with the National Electrical Code and local regulations, using only NEC Class 1 wiring for all power terminals.

It is advisable, but not necessary, to fuse one leg of the incoming power line, contact #11, with a 2AG, 0.5 amp rated fuse. *It is recommended that instrument power and load power be fused independently.*

Figure 8. Power Wiring Connection

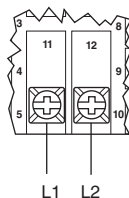

100 - 250 V 50/60 Hz
100 - 250 Vdc (Auto Polarity)

Output Types

The Type “B” output is a mechanical device and subject to wear. To extend the life of the relay, set the Cycle Time for the relay output to the longest duration that still affords good control.

When you ordered your Series C controller specific output types were specified, designated as “B”, “E”, “F”, “G”, “S”, “T” or “Y”. You also had the option of configuring your controller with either one or two output actions. The numbers below are suggested for most typical applications.

For Control Output Type —	Select Cycle Time (in seconds)
B	>15
E	0.2
F	0.2
G	0.2
S	0.2
T	15*
Y	>15





**“T” outputs directly driving non-inductive loads (small heaters) can have cycle times as low as 0.2 seconds.*

Output Type	Description
B	5 A (120/240 Vac) relay, normally open, used for switching resistive loads. If relays or solenoids are to be driven, select the “T” output. If a “B” output is selected, order snubber network 235Z005U01.
E	0-20 mA
F	4-20 mA, full output to load with 500 ohm impedance max. (suppressed).
G	High impedance ‘F’ (800 ohms).
S	20 Vdc pulsed output for solid-state relays.
T	1 A @ 120/240 Vac, solid-state relay, zero voltage-switched and optically isolated from drive signal. Only resistive loads to 1A may be controlled directly. Larger loads may be controlled using an external contactor.
Y	5 A (120/240 Vac) relay, but normally closed (output 2 only).

Operation

Figure 9. Front Panel Controls and Indicators



-  **Mode/Enter Key**
Used to enter Parameter selections, access operating modes, release latched alarms, and index through menu items.
-  **Lower Key**
Used to decrease values.
(Hold for fast-step progression)
-  **Raise Key**
Used to increase values.
(Hold for fast-step progression)
-  **Menu Access Key**
Used to enter or exit the menu system, index to the next menu, and enter the Security Level menu.

Power On





The Series C controller's functional hierarchy is organized into three distinct user-programmable groupings: Security Level, Menu System, and Operating Mode.

Please provide the software version number, communications protocol, and the controller's full model number, when contacting us regarding your controller.



When power is first applied to the Series C, all segments of the LED displays will be momentarily illuminated while the instrument goes through a series of diagnostic checks to verify proper operation. A software version number will then appear in the lower display, followed by a configuration code (upper display) and the communications protocol which is supported (lower display).

IMPORTANT: On initial startup, there is a possibility that outputs may be activated. We recommend placing the unit in Standby mode until you have configured the controller according to your application requirements. To place the controller in Standby, follow this procedure:





- 1) Press and hold Mode/Enter  key until a menu label appears in upper display (approximately three seconds).
- 2) Press Raise  or Lower  key until **Stby** appears in the lower display.
- 3) Press Mode/Enter  key. (The upper display will alternate between **Stby** and process value.)

Operations Overview

The user interface of the Series C allows you to use menus to set up the instrument, set the desired security level, change the setpoint, and conveniently change operating modes. Figure 9 on page 15 provides a functional representation of the user interface and the key presses necessary to perform the basic functions.

Security Levels

*The controller's initial security level, set at the factory, is Configuration **CnF9**. When you have completed configuring the instrument, we recommend the security level be set to the most restrictive level suitable for your application.*

The security level feature allows you to limit access to the menus, setpoint, and operating mode selection according to the needs of your application. The security levels provided are **Key Lockout**, **Setpoint**, **Setpoint plus Mode**, **User**, **Configuration**, and **Factory**. To view or change security level from the Process Variable display, press and hold the Menu Access  key for approximately 10 seconds. (Ignore the menu label that will appear in the upper display after approximately three seconds.) The controller will display **AccLo** (Access Level) and the current security level label, e.g., **USER**. Use the Raise  or Lower  keys to index through the security levels. Press the Mode/Enter  key once to select the new security level desired and return to the Process Value display.

Security Levels and Access Restrictions

Loc.0 Key Lockout	Highest security level. No access to any controller functions. To escape, follow instructions above for changing security levels.
SP Setpoint	No access to menus. Only allows setpoint value or output percentage (manual mode) to be changed.
SP.PL Setpoint plus Mode	No access to menus. Only allows setpoint value, output percentage (manual mode), or operating mode to be changed.
USER User	All "Setpoint" level privileges as well as access to Operating Mode, Autotune, and Control menus.
CnF9 Configuration	All "User" level privileges as well as Input, Output, Display, and Supervisor menus
FACt Factory	All "Configuration" level privileges as well as access to Calibration menu.

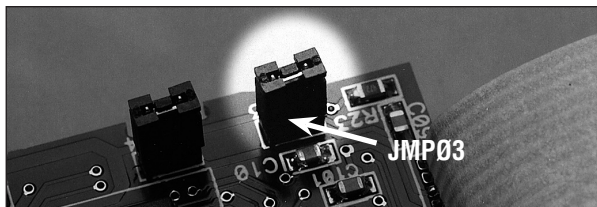











NOTE: Removing this jumper on the microcontroller board disables the keypad, thus preventing any operator access.

Operating Modes

Remember to press the Mode/Enter key after making your selection.

If both outputs are set to **OFF** or **RLr**, the Series C will function as a non-controlling indicator. Control outputs will be disabled and the Operating Modes will not be displayed.

The Series C's operating modes are: **Manual, Standby, Normal, Autotune, Ramp/Soak Recipe, Run** and **Hold**. To select a different operating mode, press the Mode/Enter  key for three seconds. The operating mode that the controller is currently in will be displayed. To index through the available operating modes, press the Raise  or Lower  keys. When the desired mode is displayed, press the Mode/Enter  key once to select the mode.

	FOP
	Stby
	nor
	Autun
	r.S
	r.S. r
	r.S. H

Manual

Standby

Normal

Autotune

(Only available when unit is placed in Standby mode and one output is PID.)

Start Ramp/Soak Recipe

(Only when programmed.)

Run

(Only available when recipe is active.)

Hold

(Only available when recipe is active.)

Operating Modes

Manual operating mode overrides automatic control, allowing you to control the outputs using a fixed percentage of output power, regardless of the process variable or setpoint.

If current automatic control is PID, transfer to Manual mode is "bumpless."

FOP Manual

Used to set control output percentage (Fixed Output Percentage) independent of Process Value. To set percentage, use the Menu Access  key to select **PcEt1** and the Raise or Lower keys to set the value. **PcEt1** is displayed if Output 1 is a control output. **PcEt2** is displayed if Output 2 is a control output.

Stby Standby

Used to disable control outputs.

nor Normal

Normal automatic control.

Autun Autotune

Used to initiate the autotuning sequence (from Standby only).

r.S Ramp/Soak Recipe

Used to start ramp/soak recipe mode.

r.S. r Run





Used to enable Run function

r.S. H Hold

Used to enable Hold function

Menu System Overview

If a key press is not sensed within five minutes, the controller automatically exits the Menu System and reverts to the Process Value display.

The Parameter Menu System is organized into ten basic menus: **Input, Display, Output, Control, Alarm, Tune, Recipe, Supervisor, Calibration,** and **Option**. To access the Menus, press and hold the Menu Access  key for approximately 3 seconds until a menu label appears in the upper display. There are additional menus presented when an option is selected under the Option menu; however, the options are non-functional unless the appropriate option board has been installed. Pressing the Menu Access  key indexes from menu to menu. Pressing the Mode/Enter  key indexes through the parameters in a particular menu. The Raise and Lower   keys are used to modify the visible menu parameter.

Each menu contains a logical group of parameters related to one another. Furthermore, the sequence of the menus has been carefully chosen to put the most important setup menus first.

Menu System Overview

To return to Process Value at any time, press and hold Menu Access  key for three seconds

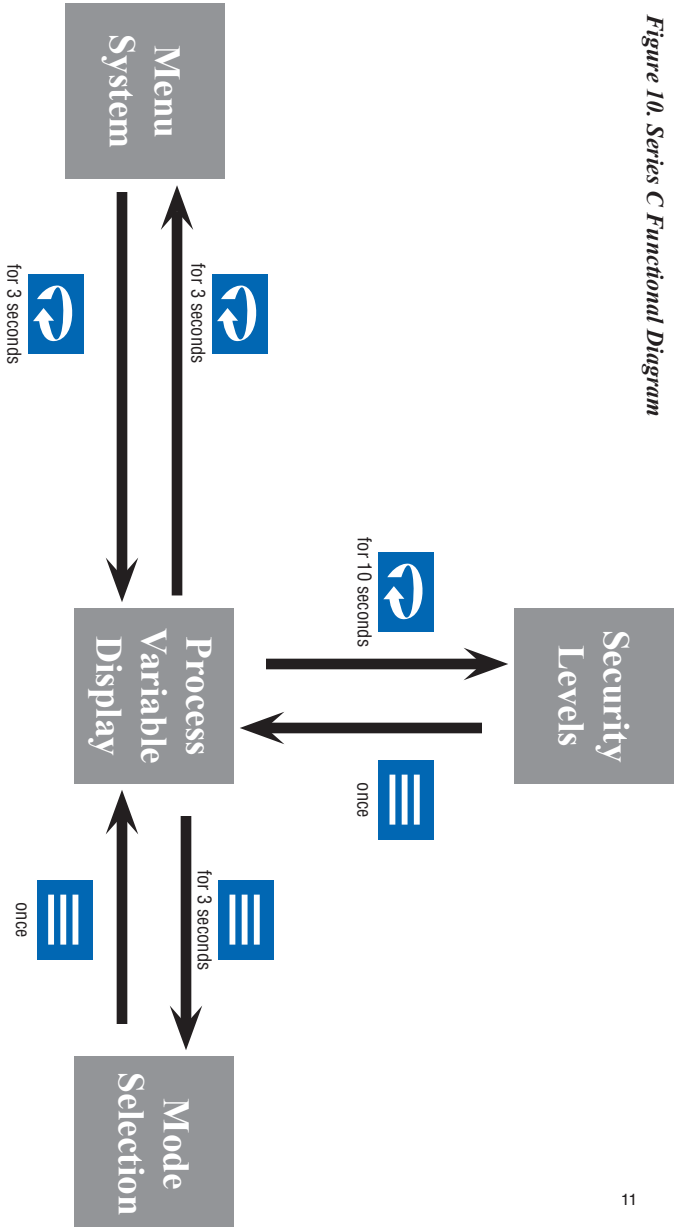

Figure 10. Series C Functional Diagram

Menu System Overview

Figure 11. Chart of Series 16C Menu System and Security Levels
(Continued on Next Page)



Menu Access Key



Mode/Enter Key



- Notes:**
1. It is recommended you start with the input menu.
 2. Parameter labels displayed will vary, depending upon the controller's configuration.

INP	dSP	OUTP	Ctrl	ALR	tUNE	r-S		
tYPE	dECP	01.tY 01.Ac	db.1	R1.AA	dPn9	8.rS	r.OPt	dIS
SCLL	dFIL	01.cY 01.LL	WYS.1	R1.dL	HLdb	SSPr		
SCLH	Un.t	01.HL 01.AA	db.2	R1.H	tEr.S	SSr.t		
SPLL	bLRn	01.A0 01.dL	WYS.2	R1.SP	rcY.n	HLdb		
SRAH		01.H 01.SP	Pb.1	R2.AA	pFrE	tEr.S		
IFIL		02.tY 02.Ac	Pb.2	R2.A0	r.t	(number)		
		02.cY 02.LL	dEr	R2.dL	rE	(number)		
		02.HL 02.AA	OFFS	R2.H	SL	(number)		
		02.A0 02.dL	Int	R2.SP	SE	(number)		
		02.H 02.SP			SE	(number)		

**Figure 11. Chart of Series 16C Menu System
and Security Levels**
(Continued from Previous Page)

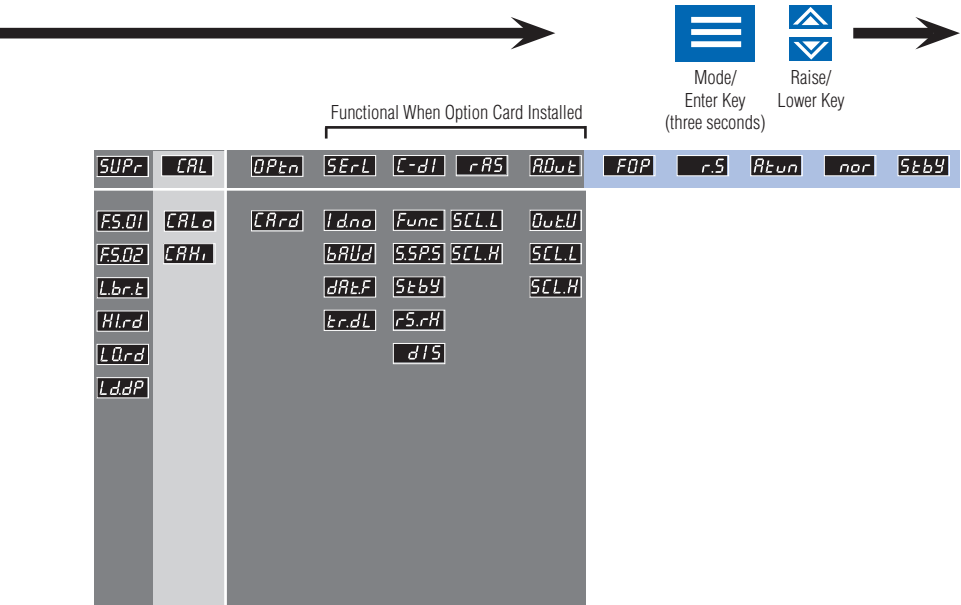

*** See options manual for
parameter selections.**

Security Levels	
Loc.0	(Key Lockout) = No Access
SP	(Setpoint) = Setpoint Value or Output Percentage (Manual Mode)
SP.PL	(Setpoint plus Mode) = SP Plus
USER	(User) = SP.PL Plus
CnF9	(Configuration) = USER Plus
FACT	(Factory) = CnF9 Plus

Menus and Parameter Descriptions

Menus and Parameters

INP Input	Used to select sensor-related parameters, such as input type, limits, and scaling.
dSP Display	Used to set or change decimal position and display units.
OUTP Output	Used to specify output usage, control methods, and alarms.
CTRL Control	Used to select parameters associated with the control methods.
ALR Alarm	Used to select alarm parameters .
	Note: This menu is also functional for controllers <u>not</u> equipped with alarm hardware; however, alarm indication will be only visual via the A1 and A2 LEDs on the front panel.
tUNE Tune	Used to set the autotune damping parameter.
r-S Recipe	Used to set ramp and soak parameters.
SUPr Supervisor	Used to set fail-safe and supervisory parameters.
CR Calibration	Used to recalibrate input.
OPtN Option	Used to select installed option.
SERL Communications	(Option) Used to set serial communications parameters.
C-dI Contact/Digital Input	(Option) Used to select switch input functions.
rRS Remote Analog Setpoint	(Option) Used to enter remote analog setpoint parameters.
ADUe Auxiliary Output	(Option) Used to set auxiliary output parameters.

Input Menu

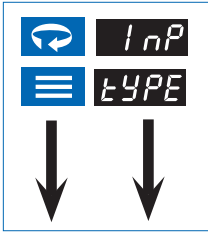

NOTE: FOR A MORE DETAILED DESCRIPTION OF MENU PARAMETERS, REFER TO THE GLOSSARY WHICH BEGINS ON PAGE 64.

The first parameter that needs to be set is **Input Type**. The remaining Input Menu parameters will change, depending upon whether a linear input type or a temperature input type is selected. Other menu parameters related to the sensor range may also change. After selecting your **Input Type**, refer to the corresponding section on page 16 for the remainder of the Input Menu parameters.

Input Menu

Display Parameter

tYPE Input Type

Selection

- d** Type J thermocouple
- b** Type B thermocouple
- C** Type C thermocouple
- E** Type E thermocouple
- K** Type K thermocouple
- n** Type N thermocouple
- n.C** Type NIC thermocouple
- nn** Type NNM thermocouple
- r** Type R thermocouple
- S** Type S thermocouple
- t** Type T thermocouple
- PL2** Platinel II thermocouple
- rtd** 100 ohm platinum RTD

Input Menu

Input Menu (continued)

Display Parameter

EYPE Input Type

Selection

- rtd** 100 ohm compressed RTD
- 0.20A** 0-20 mA
- 4.20A** 4-20 mA
- 0.10** 0-10 mV
- 0.50** 0-50 mV
- 0.100** 0-100 mV
- 10.50** 10-50 mV
- 0-1** 0-1 V
- 0-5** 0-5 V
- 0-10** 0-10 V
- 1-5** 1-5 V

Input Jumper Settings

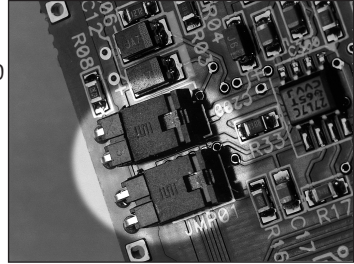

Input Type	JMP01	JMP02
Thermocouple	Out	Out
RTD	Out	Out
Voltage <100 mV	Out	Out
Voltage >100 mV	In	Out
Current Process	In	In

Note: When you ordered your controller, an input type was specified and the controller was set up accordingly and calibrated for that input type at the factory. If you decide to change input type from thermocouple to RTD or vice-versa, you will need to recalibrate the controller unless you ordered the “Calibrate All” option. (Refer to page 56 for information on recalibration.) If you are changing from a temperature input type to a linear input type, you MUST recalibrate and change the jumper settings as indicated in the above table.

Input Menu

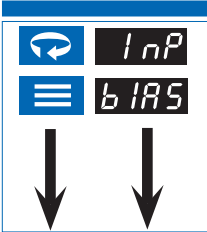

Temperature Input Type

Display Parameter

- bIAS** Bias (Display offset)
- SPLL** Lower Setpoint Limit
- SPHL** Upper Setpoint Limit
- I.FIL** Filtering

Selection

- 100 to 100
- Span of Sensor
- Span of Sensor
- 0.1-10.0 sec.

Linear Input Type

Display Parameter

- bIAS** Bias (Display offset)
- SECL** Low Scale
- SECH** High Scale
- SPLL** Lower Setpoint Limit
- SPHL** Upper Setpoint Limit
- I.FIL** Filtering

Selection

- 100 to 100
- 1999 to 9999
- 1999 to 9999
- Span of Sensor
- Span of Sensor
- 0.1-10.0 sec.

Display Menu

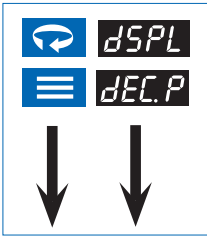

Display Parameter

dECLP Decimal Position

dFIL Filter

UnIt Units*

Selection

0-3 Linear Inputs

0-1 TC/RTD

0.1-10.0 sec

F Fahrenheit

C Celsius

KRY Kelvin

*NOTE: Does not appear for linear inputs.

bLkOn Blanking

(Time selected before
setpoint display turns off.)

OFF, 0-9999 sec

Output Menu

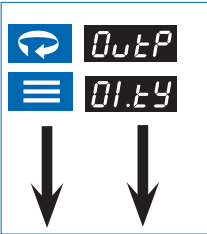

The first parameter that needs to be set in the Output Menu is the **Output Type**. There are three possible **Output Type** configurations: PID, On/Off, Alarm, or Off. (If you are not sure which **Output Type** is best for your particular application, refer to the **Glossary** for an explanation of **Output Types**.) The remaining menu parameters in the Output Menu will change, depending on the **Output Type** selected. The Control Menu will also change, depending on the **Output Type** selected. If you ordered two outputs, you can select two different **Output Types**. After setting your **Output Type**, refer to the corresponding sections below for the remaining Output Menu parameters. For simplification purposes, the following sections assume the same **Output Type** for both outputs. If you selected different **Output Types**, refer to both of those sections.

Output Type

Display Parameter

01.tY Output 1 Type

02.tY Output 2 Type

Selection

PId

OnOff

OFF

ALr

PId

OnOff

OFF

ALr

Output Menu

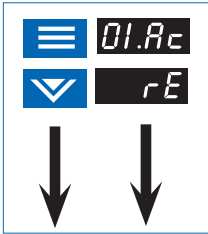

PID Output Type

01.Rc Output 1 Action	rE Reverse-acting (Heating)
	dIr Direct-acting (Cooling)
01.cY Output 1 Cycle Time*	0.2; 1 to 120 seconds
01.LL Output 1 Low Limit	1-100%
01.HL Output 1 High Limit	1-100%
02.Rc Output 2 Action	rE Reverse-acting (Heating)
	dIr Direct-acting (Cooling)
02.cY Output 2 Cycle Time*	0.2; 1 to 120 seconds
02.LL Output 2 Low Limit	1-100%
02.HL Output 2 High Limit	1-100%

*Recommended Cycle Time Settings

Output Type	Recommended Setting (seconds)
B (5A/3A)	15 to 120
E (0-20 mA)	0.2
F (4-20 mA)	MUST be set to 0.2
G (4-20 mA)	MUST be set 0.2
S (pulsed 20 Vdc)	0.2
T (S.S. relay)	15 to 120**
Y (5A/3A) N.C.	15 to 120 (Output 2 only)

***T** outputs directly driving non-inductive loads (small heaters) can have cycle times as low as 0.2 seconds.

Control Menu

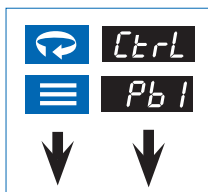

Setting Derivative (Rate) or Integral (Reset) to **0** disables that aspect of PID control.

If BOTH outputs are set to direct-acting or BOTH outputs are set to reverse-acting, then only one proportional band selection will be displayed.

PID Output Type

As with the Output Menu, the Control Menu will change, depending upon the Output Type selected. *Note: These parameters are automatically set during the autotune procedure. We do not recommend altering the value of these control parameters unless your process requires manual tuning.*

Display	Parameter	Selection
Pb1	Proportional Band 1	1...to span of sensor
Pb2	Proportional Band 2	1...to span of sensor
dEr	Derivative Action (Rate)	0 to 2400 seconds
OFFS	Manual Reset	OFF, -100% to 100%

NOTE: The Integral Action (Auto Reset) parameter appears only if OFF is selected in the Manual Reset parameter.

Int	Integral Action (Auto Reset)	0 to 9600 seconds
------------	------------------------------	-------------------

Output Menu

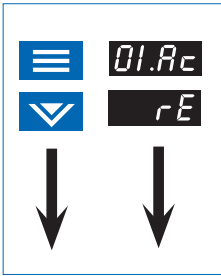

On/Off Output Type

Display **Parameter**

01.Rc Output 1 Action

02.Rc Output 2 Action

Selection

rE Reverse-acting (Heating)

dIr Direct-acting (Cooling)

rE Reverse-acting (Heating)
Direct-acting (Cooling)

dIr

Control Menu

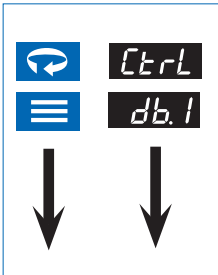

On/Off Output Type

*If both outputs are set to **OFF** in the Output Type Menu, the controller will function as a non-controlling indicator. Control outputs will be disabled and the Operating Modes will not be displayed.*

Display **Parameter**

db.1 Deadband 1

HYS.1 Hysteresis Output 1

db.2 Deadband 2

HYS.2 Hysteresis Output 2

Selection

Negative span of sensor to
positive span of sensor

1...to span of sensor

Negative span of sensor to
positive span of sensor

1...to span of sensor

Notes On Alarms

Outputs can be set up as an alarm, similar to the standard alarm format. Four types of alarms are available: Process, Deviation, Inverse Band, and Normal Band. All alarms may be configured to be inhibited on power-up for a configurable time duration.

Process Alarm: Activates at preset value, **independent** of setpoint. “High” process alarm activates at and above alarm setting. “Low” process alarm activates at and below alarm setting.

Deviation Alarm: Activates at a preset **deviation** value from setpoint. “High” or “Low” deviation alarm activates above or below setpoint according to the preset deviation value.

Inverse Band Alarm: Activates when the process is **within** a specified band centered around the setpoint.

Normal Band Alarm: Activates when the process **exceeds** a specified band centered around the setpoint.

Deviation, Inverse Band, and Normal Band Alarms track with setpoint.

Latching Alarms

The Series C's alarms may also be configured as latching alarms by selecting **LRL** in the Alarm Action parameter selection.

When a latching alarm has been activated and the alarm condition has been removed, the Mode/Enter  key must be pressed to unlatch the alarm.

Output Menu

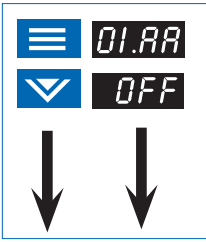

Note: The Control Menu does not apply to an Alarm Output Type; therefore, the Control Menu does not appear.

*Alarms A1 & A2 can be set up using this same information in the **ALr** menu.*

Alarm Output Type

Display Parameter

01.AA Output 1 Alarm Action

01.AO Output 1 Alarm Operation

01.dL Output 1 Alarm Delay

01.IH Output 1 Alarm Inhibit

01.SP Output 1 Alarm Setpoint

02.AA Output 2 Alarm Action

02.AO Output 2 Alarm Operation

02.dL Output 2 Alarm Delay*

02.IH Output 2 Alarm Inhibit**

02.SP Output 2 Alarm Setpoint

Selection

OFF

LAR (Latching)

nor (Normal)

Pro.L (Process Low)

Pro.H (Process High)

in.b (Inverse Band)

nor.b (Normal Band)

dEL (Deviation Low)

dEH (Deviation High)

0-9999 sec

0-9999 sec

Span of Sensor

OFF

LAR (Latching)

nor (Normal)

Pro.L (Process Low)

Pro.H (Process High)

in.b (Inverse Band)

nor.b (Normal Band)

dEL (Deviation Low)

dEH (Deviation High)

0-9999 sec

0-9999 sec

Span of Sensor

*Alarm Delay - the time delay between the detection of the alarm condition and the initiation and indication of the output action.

**Alarm Inhibit - prevents low setpoint alarm activation during cold startup applications.

Autotune Damping Menu

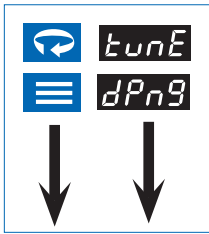

Display Parameter

dPn9 Damping

Selection

Lo Low

nL Normal

Hi High

Note: The damping parameter specifies how aggressively the controller performs its autotuning. The “Normal” setting is a compromise between the fast recovery and overshoot. The “Low” setting provides faster recovery, but with the possibility of overshoot; the “High” setting a slower recovery, but with minimum or no overshoot.

Recipe (Ramp/ Soak) Menu

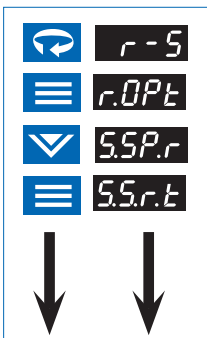

Single Setpoint Ramp Time

This selection will cause the controller to ‘ramp’ the process from the starting point (current process value) to the setpoint in the time specified. This ramp will take place at startup when selected from the Ramp/Soak menu. The setpoint must be at least $\pm 0.2\%$ of sensor span for the ramp to be employed.

Multi-Step Ramp

This selection will enable the programming of a recipe (make all ramp/soak recipe variables visible). Recipes can be resumed on startup if interrupted by a power failure or initiated, held, and terminated from the front panel via the Mode Menu or with the logic input option (initiate and held/resumed only).

Holdback Band

Specifies the maximum number of degrees above or below setpoint that the process can be for the segment timer to keep going. The timer will hold while the process settles back into the band and then continue. If this feature is not desired, this parameter should be set to **OFF** which will disable it.

Termination State

This parameter determines what the control will do at the completion of a recipe. Last Setpoint refers to the last temperature specified in the ramp/soak recipe. Default Setpoint refers to the standard setpoint which was in effect prior to recipe initiation.

Recycle Number

Specifies the number of times **after** the first time that the recipe is run before the program terminates.

Recipe (Ramp/ Soak) Menu

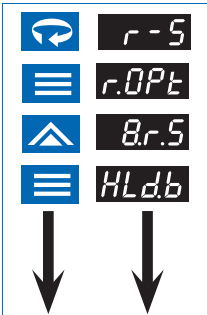

If a ramp/soak error condition occurs, the upper display will toggle between **r-5** and the numeric error code for three seconds before the recipe terminates. Possible error codes are:
 02 = Recipe Empty (i.e. no non-zero ramp times)
 05 = Insufficient Setpoint-Process Value Deviation

Power Fail Resume

Setting this parameter to On will cause the control to resume a recipe which was active when a power failure occurred. The recipe will resume at the start of the last active ramp or soak segment.

Ramp/Soak Events (1-8) (If alarms are configured as ramp/soak events.)

Ramp/Soak events occur at the beginning of their designated segment. All events are terminated once the recipe has been completed or terminated. This can be used as an alarm when a segment is reached.

Display Parameter

r.OPt Recipe Option

SS.r.t Single-Setpoint Ramp Time*

HLdb Holdback Band

TEr.S Termination State

Selection

SSP.r Single-Setpoint Ramp

8.r.5 Multi-Step Ramp

d15 Disabled

1-9999 mins.

Off-100 degrees

LRSt Last Setpoint

dEFt Default Setpoint

Stby Recipe to Standby

*NOTE: Only available when single-setpoint ramp is selected.

Recipe (Ramp/ Soak) Menu

For Ramp Events and Soak Events to be employed, Alarm 1 or Alarm 2 must be set for event usage **Event** in the Alarm Menu.

NOTE: The following seven parameters are only available when multi-step ramp is selected.

Display Parameter

rcy.n	Recycle Number (Recipe Executions)
Pf.rE	Power Fail Resume
rt	Ramp Times 1-8
rE	Ramp Events 1-8
SL	Soak Levels 1-8
St	Soak Times 1-8
SE	Soak Events 1-8

Selection

0-99, cont
OFF Off
on On
0-9999 mins.
Al.on Alarm 1 On
Al.oF Alarm 1 Off
R2.on Alarm 2 On
R2.oF Alarm 2 Off
d1S Disabled
Display Units, FS
0-9999 mins.
Al.on Alarm 1 On
Al.oF Alarm 1 Off
R2.on Alarm 2 On
R2.oF Alarm 2 Off
d1S Disabled

Supervisor Menu

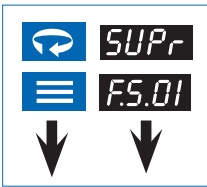

The Failsafe State is only enforced when a problem is detected with the process input. It is not reliably enforceable in instances of internal circuitry failure such as EEPROM problems.

Output % High Limits are ignored when the unit enters a Failsafe State.

Display Parameter

FS.01	Output 1 Failsafe State
FS.02	Output 2 Failsafe State
L.br.t	Loop Break Time
Hl.rd	Highest Reading
Lo.rd	Lowest Reading
L.d.dP	Load Default Parameters

Selection

0 to 100% of output
0 to 100% of output
Off, 4-9600 sec
n/a
n/a
YES
no

Choosing "Yes" to Load Default Parameters resets all menu parameters to factory settings.

Calibration Menu

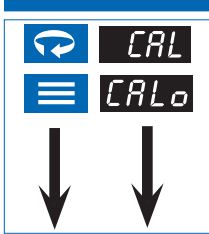

CALo

Toggles with the temperature value that should be input to perform the low calibration operation.

The low calibration operation is triggered by pressing the up arrow key.

CALh

Toggles with the temperature value that should be input to perform the high calibration operation.

The high calibration operation is triggered by pressing the up arrow key.

Options Menu

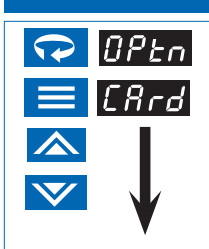

Display Parameter

CARd Installed Card

Selection

nonE

SERL Serial Communications

SCdI Serial Communications with Switch Input

rAS Remote Analog Setpoint

A.OuE Auxiliary Output

ALr Alarm

dI.AL Switch Input with Alarm

Note: See options manual for parameter selections.



Autotuning

In order for the controller to autotune properly, the setpoint value must be at least 1% of span above or below the initial process value. Make sure that the Setpoint Target Time parameter is set to OFF.

Tuning accuracy increases as the spread between ambient and setpoint value increases.

Tuning should be performed with system in equilibrium (no latent energy remaining).

To place the controller in Autotune mode:

- 1) Configure the controller** by following the directions for Initial Setup Sequence through Step 3 on page 7. Set damping parameter. (See page 22.)
- 2) If the controller is not already in Standby mode, place it in Standby** now as follows. Press and hold the Mode/Enter  key for three seconds. Display will indicate your current operating mode. Press the Raise  key or Lower  key to select Standby. Press Mode key again and the display will alternate between **Stby** and the process value. This will deactivate all outputs.
- 3) If Setpoint Value has not been entered, adjust setpoint** now by using the Raise or Lower key to set the desired setpoint.
- 4) Wait for process to stabilize** before proceeding, e.g., in the case of a heating and cooling process, return to ambient temperature.
- 5) Initiate Autotuning.** Press and hold the Mode/Enter key again for three seconds, then press the Raise or Lower key repeatedly until **Retun** appears. Finally, press the Mode/Enter key again. The display will alternately indicate **tunE** and process value as the controller “learns” the proper proportional band, derivative, and integral values for the process. If unacceptable overshoot occurs on restart, shut down the process and increase the damping setting. If sluggish response is observed, shut down the process and decrease the damping setting.

Autotuning

If a tune error condition occurs, the upper display will toggle between **tuneE** and a numeric error code for three seconds before the tune process terminates. The controller will then automatically go into Standby mode when a tuning error occurs. Possible error codes are:

- 02 = No PID Device Configured
- 03 = Incorrect Output Action
- 05 = Insufficient Setpoint-Process Value Deviation
- 08 = Invalid Tune Results
- 09 = Tune Timeout

Autotuning Procedure Diagram

Note: Keep in mind that the setpoint value must be at least 1% of span above or below the initial setpoint, and that the process value must be stable prior to initiating the tune.

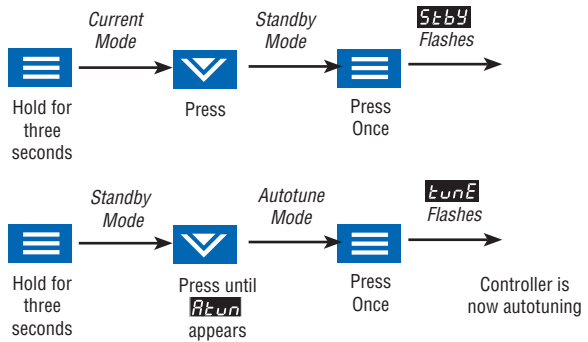

Manual Tuning

While some processes other than heat or cool applications may respond successfully to autotuning procedures, the controller may need to be manually tuned for non-temperature processes.

Manual Tuning Procedure (Zeigler-Nichols PID Method)

This tuning method may be used for non-temperature control processes or if the spread between ambient temperature and process operating temperature is small. For best results, the use of a recording device is required when tuning with this method.

- 1) For temperature control processes, disable any cooling device used.
- 2) With the power off and the controller NOT in the Key Lockout security level, apply power and immediately put the controller in Standby mode by pressing the Mode/Enter \equiv key for three seconds, the Raise \blacktriangle key until **Stby** appears and press the Mode/Enter \equiv key again.
- 3) If you have a direct-acting output, it must be disabled before proceeding further **02ty** = **OFF**.
- 4) Under the Control menu, make sure that the derivative term **dEr**, the offset term **OFFS**, and the integral term **Int** are all set to zero, and the proportional band **Pb1** or **Pb2** is set to the maximum setting.
- 5) Adjust setpoint to the desired value with the Raise/Lower keys.
- 6) Press the Mode/Enter \equiv key for four seconds, the Raise \blacktriangle key twice **nor**, and the Mode/Enter key again to return the controller to normal operation.
- 7) While monitoring the recording device, decrease the proportional band value by repeatedly halving the value until a small, sustained temperature oscillation is observed. Measure the period of one cycle of oscillation ("T" on the diagram below).

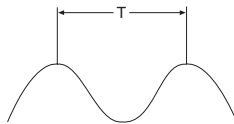

- 8) Divide the period of oscillation (T) by eight. The resulting number is the correct Derivative **dEr** time in seconds. Multiply this number by four. This is the correct Integral time **Int** in seconds.
- 9) Multiply the bandwidth value obtained in Step 7 by 1.66 and enter this as the new proportional band value.

Error Codes

If an error code cannot be cleared by using the actions provided, contact factory.

Display	Problem	Actions
Err.H	Open Sensor	Check sensor, wiring, and Input.
Err.L	Reversed Sensor	Check the type selection in the Input menu, and check sensor polarity.
LPbr	Loop Break	Correct problem and reset controller.
0100	Checksum Error	Press any key to perform a soft reset and reinitialize controller.
0101	RAM Error	
0202	Defaults Loaded	
0303	EEPROM Write Failure	
3865	Power Fail Resume Feature Disabled	No further resume actions available.
36 Plus other 2-Digit Code	Unexpected or Invalid Interrupt	Reset controllers

Autotune Errors

If a tune error condition occurs, the upper display will toggle between **tune** and a numeric error code for three seconds before the tune process terminates. The controller will then automatically go into Standby mode when a tuning error occurs. Possible error codes are:

- 02 = No PID Device Configured
- 03 = Incorrect Output Action
- 05 = Insufficient Setpoint-Process Value Deviation
- 08 = Invalid Tune Results
- 09 = Tune Timeout

Ramp/Soak Errors

Possible error codes are:
02 = Recipe Empty (i.e. no non-zero ramp times)
05 = Insufficient Setpoint-Process Value Deviation

Technical Specifications

Operating Limits

Ambient Temperature	32°F to 140°F (0°C to 60°C)
Relative Humidity Tolerance	90%, Non-Condensing
Power	100 to 250 V 50/60 Hz (Single-Phase) 100 to 250 Vdc 24 Vac/dc
Power Consumption	Less than 6 VA

Performance

Accuracy	±0.20% of Full Scale (±0.10% Typical), ±1 Digit
Setpoint Resolution	1 Count / 0.1 Count
Repeatability	±1 Count
Temperature Stability	5 µV /°C (Maximum)
TC Cold-End Tracking	0.05°C /°C Ambient
Noise Rejection	>100 dB Common Mode, >70 dB Series Mode
Process Sampling	10 Hz (100 ms)

Control Characteristics

Setpoint Limits	Automatically Adjust to Selected TC/RTD
Alarms	Adjustable for High/Low; Selectable Process, Deviation, or Band Alarms
Proportional Band	1 to Span of Sensor
Integral	0 to 9600 Seconds
Derivative	0 to 2400 Seconds
Cycle Time	200 ms; 1 to 120 sec
Control Hysteresis	1 to Span of Sensor
Autotune	Operator Initiated from Front Panel
Manual Control	Operator Initiated from Front Panel

Mechanical Characteristics

Display	Dual, 4-digit 0.36" (9.2 mm) LED display Process Value: Orange Setpoint Value/Menu: Green
Numeric Range	-1999 to 9999
Front-Panel Cutout	1.771" x 1.771" (45 mm x 45 mm)
Depth Behind Panel	3.937" (100 mm)
Front Panel Rating	NEMA 4X
Operating Temperature	32 to 140° F (0 to 60° C)
Humidity Conditions	90% R.H. max., non-condensing
Parameter Retention	Solid-state, non-volatile memory
Connections	Input and output via barrier strip with locking terminals
Contacts	Twin bifurcated

Technical Specifications

Input Type

Thermocouple	B, C, E, J, K, N, NIC, NNM, R, S, T, Platinel II Maximum lead resistance 100 ohms for rated accuracy
RTD	Platinum 2- and 3-wire, 100 ohms at 0° C, DIN curve standard (0.00385) 1000 ohms available
Linear	0-50 mV/10-50 mV, 0-5 V/1-5 V 0-20 mA/4-20 mA, 0-100 mV, 0-10 V

Output Device

B	5 A (120/240 Vac) relay, normally open, used for switching resistive loads. If relays or solenoids are to be driven, select the "T" output. If a "B" output is selected, order snubber network 235Z005U01.
E	0-20 mA
F	4-20 mA, full output to load with 500 ohm impedance max.
G	High impedance 'F' (800 ohms max.)
S	20 Vdc pulsed output for solid-state relays.
T	1 A @ 120/240 Vac , solid-state relay, zero voltage-switched and optically isolated from drive signal. Only resistive loads to 1A may be controlled directly. Larger loads may be controlled using an external contactor.
Y	5 A (120/240 Vac) relay, but normally closed (output 2 only).

Alarm Type

See ordering code on page 55.

Ordering Codes

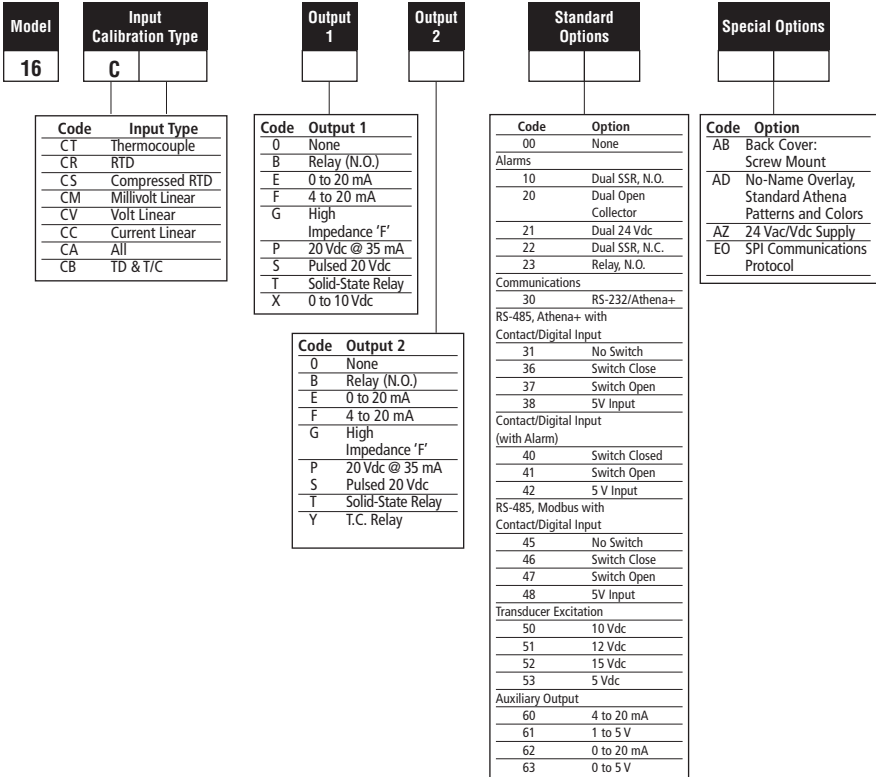

Recalibration Procedures

The Series C controller is precalibrated at the factory. Under normal circumstances, the factory calibration should be valid for the life of the instrument. If recalibration should be required, allow the controller to warm up for 15 minutes and follow these steps carefully.



- 1) Remove power from the controller and disconnect all output devices. Disconnect input. Attach an appropriate calibrator to the input terminals.
- 2) Apply power to the calibrator, making sure that the displayed value is not outside the range of the controller. Then, apply power to the controller.
- 3) Index to the Calibration Low menu item in the Calibration Menu.
(You must have Security Level set to “Factory” to access this menu.)
- 4) Dial Calibrator to prompted value on the controller’s display. See chart below for RTD resistance vs. temperature values.
- 5) Allow the controller to settle for at least one minute.
- 6) Press Raise  Key.
- 7) Repeat Steps 4, 5, and 6 for the Calibration High setting.
- 8) Press the Menu Access key for three seconds to return to the Process Value display.















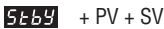



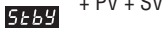

RTD Calibration Values				
RTD	Cal Lo	0° C	32° F	100Ω
RTD	Cal Hi	768° C	1414° F	366Ω
RT.D	Mid-range	328° C	622.4° F	222Ω

Quick-Helps



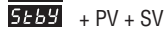





1. To return the unit to last operating mode (Normal, Standby, FOP, or Tune):

	Action	Display
From Menu System:	Press and hold  for 3 sec.	PV + SV + Mode
From Security Level Menu:	Press 	PV+ SV + Mode







2. To enter Standby operating mode:

	Action	Display
From Normal operating mode:	Press and hold  for 3 sec.	
	Press 	
From FOP (Manual) operating mode:	Press 	
	Press and hold  for 3 sec.	
From Menu System:	Press 	
	Press 	
	Press and hold  for 3 sec.	
From Security Level Menu:	Press and hold  for 3 sec.	
	Press 	
	Press 	
	Press 	
	Press 	

3. To escape from Standby operating mode:





Action	Display
Press 	
Press and hold  for 3 sec.	
Press 	
Press 	

4. To initiate Autotuning:





Action	Display
Enter Standby operating mode (See Quick-Help #2)	
Press 	
Press 	
Press 	

Quick-Helps

5. To abort Autotuning and return to normal operation:

Action	Display
Press and hold  for 3 sec.	
Press 	

6. To enter FOP (Manual) operating mode:





Action	Display
Press 	PV + SV
Press and hold  for 3 sec.	
Press 	 + PV + % of Power Value

Press   to set new % of Power Value

Press  to set % of Power for Output 2 if desired.

	+ PV + % of Power Value
---	-------------------------

7. To escape from FOP (Manual) operating mode:

Action	Display
Press and hold  for 3 sec.	
Press 	
Press 	PV + SV

Warranty/ Repairs

Two-Year Limited Warranty

THIS EQUIPMENT IS WARRANTED TO BE FREE FROM DEFECTS OF MATERIAL AND WORKMANSHIP. IT IS SOLD SUBJECT TO OUR MUTUAL AGREEMENT THAT THE LIABILITY OF ATHENA CONTROLS, INCORPORATED IS TO REPLACE OR REPAIR THIS EQUIPMENT AT ITS FACTORY, PROVIDED THAT IT IS RETURNED WITH TRANSPORTATION PREPAID WITHIN TWO (2) YEARS OF ITS PURCHASE.

THE PURCHASER AGREES THAT ATHENA CONTROLS, INCORPORATED ASSUMES NO LIABILITY UNDER ANY CIRCUMSTANCES FOR CONSEQUENTIAL DAMAGES RESULTING FROM ITS USE OR FROM IMPROPER HANDLING OR PACKAGING OF SHIPMENTS RETURNED TO THE FACTORY. COMPONENTS WHICH WEAR OR WHICH ARE DAMAGED BY MISUSE ARE NOT WARRANTED. THESE INCLUDE CONTACT POINTS, FUSES, ELECTROMECHANICAL RELAYS, AND TRIACS. UNITS WHICH HAVE BEEN MODIFIED BY A CUSTOMER IN ANY WAY ARE NOT WARRANTED.

Other than those expressly stated herein, THERE ARE NO OTHER WARRANTIES OF ANY KIND, EXPRESS OR IMPLIED, AND SPECIFICALLY EXCLUDED BUT NOT BY WAY OF LIMITATION, ARE THE IMPLIED WARRANTIES OF FITNESS FOR A PARTICULAR PURPOSE AND MERCHANTABILITY.

IT IS UNDERSTOOD AND AGREED THE SELLER'S LIABILITY WHETHER IN CONTRACT, IN TORT, UNDER ANY WARRANTY, IN NEGLIGENCE OR OTHERWISE SHALL NOT EXCEED THE RETURN OF THE AMOUNT OF THE PURCHASE PRICE PAID BY THE PURCHASER AND UNDER NO CIRCUMSTANCES SHALL SELLER BE LIABLE FOR SPECIAL, INDIRECT, INCIDENTAL OR CONSEQUENTIAL DAMAGES. THE PRICE STATED FOR THE EQUIPMENT IS A CONSIDERATION IN LIMITING SELLER'S LIABILITY. NO ACTION, REGARDLESS OF FORM, ARISING OUT OF THE TRANSACTIONS OF THIS AGREEMENT MAY BE BROUGHT BY PURCHASER MORE THAN ONE YEAR AFTER THE CAUSE OF ACTION HAS ACCRUED.

SELLER'S MAXIMUM LIABILITY SHALL NOT EXCEED AND BUYER'S REMEDY IS LIMITED TO EITHER (i) REPAIR OR REPLACEMENT OF THE DEFECTIVE PART OR PRODUCT, OR AT SELLER'S OPTION (ii) RETURN OF THE PRODUCT AND REFUND OF THE PURCHASE PRICE, AND SUCH REMEDY SHALL BE BUYER'S ENTIRE AND EXCLUSIVE REMEDY. THE SPECIFICATIONS PUT FORTH IN THIS MANUAL ARE SUBJECT TO CHANGE WITHOUT NOTICE.

Warranty/ Repairs

Unit Repairs

It is recommended that units requiring service be returned to an authorized service center. Before a controller is returned for service, please consult the service center nearest you. In many cases, the problem can be cleared up over the telephone. When the unit needs to be returned, the service center will ask for a detailed explanation of problems encountered and a Purchase Order to cover any charge. This information should also be put in the box with the unit. This should expedite return of the unit to you.

This document is based on information available at the time of its publication. While efforts have been made to render accuracy to its content, the information contained herein does not purport to cover all details or variations in hardware, nor to provide for every possible contingency in connection with the installation and maintenance. Features may be described herein which are not present in all hardware. Athena Controls assumes no obligation of notice to holders of this document with respect to changes subsequently made.

Proprietary information of Athena Controls, Inc. is furnished for customer use only. No other use is authorized without the written permission of Athena Controls, Inc.

IEC Requirements



USE OF THIS EQUIPMENT IN A MANNER NOT SPECIFIED BY THE MANUFACTURER MAY IMPAIR PROTECTION PROVIDED BY THE EQUIPMENT!

The maximum supply current is line voltage dependent:

230 mA for a 24 Vac/dc input fuse rating=700 mA
60 mA for an 85-250 Vac input fuse rating=100 mA

Output Specifications

Output Type	Max current	Voltage	Leakage
B	5 A	250 Vac	1000 M ohms
T	1 A	250 Vpk	1 mA
S	20 mA	5 V	NA

CLEANING INSTRUCTIONS

1. Remove power from the unit prior to any cleaning operation.
2. Use a cotton cloth to gently and sparingly apply isopropyl alcohol only. Do not use cleaners or other solvents as they may damage the unit.
3. Allow the unit to dry completely prior to reapplying power.

Glossary

[Alarm Delay](#) - the time delay between the detection of the alarm condition and the initiation and indication of the output action.

[Alarm Inhibit](#) - prevents low setpoint alarm activation during cold startup applications.

[Bias](#) - allows the operator to compensate for any difference between sensor temperature and the point to be measured. The process display and setpoint will be offset by the value entered in the Bias parameter in the input menu. Ex: Desired temperature is 150 degrees. Sensor is adjacent to heater and reads 50 degrees higher than the actual process temperature. Enter bias of -50. Enter setpoint of 150. Process will display 150 even though sensor will be measuring 200 degrees.

[Blanking](#) - controls the time the setpoint value display remains on. After the set time, the setpoint value display turns off. Pressing any button causes the setpoint value display to reappear for the selected time interval.

[Cycle Time](#) - The period of time in which the controller's output completes an on-off cycle (Proportional Output Type only).

Example: Output type = Mechanical relay

Cycle time = 10 seconds

Output power = 50%

Controller output = 5 seconds closed,

5 seconds open

[Deadband](#) - In On/Off temperature control, it is the band above or below the setpoint where there is no output action. It has the effect of moving the apparent setpoint.

[Derivative](#) (rate) - Adjusts the controller gain quickly in response to load changes.

[Failsafe State](#) - designates the percentage of power output that the controller defaults to after it detects a loop break condition and after the loop break time has elapsed.

[Filter](#) (in Display menu) - changes the filtering speed for the process value display only. It does not affect control. This parameter is mainly used to slow down the flickering of the display when the decimal position chosen is greater than zero.

[Filtering](#) (in Input menu) - sets the time period over which the process value is averaged.

[Highest Reading](#) - records the highest process value read by the controller. It may be reset to zero by using the Raise or Lower arrow keys.

[Hysteresis](#) - In On/Off temperature control, hysteresis represents the band where the output changes state from deactivated to activated. It prevents chattering around the setpoint and prevents rapid output cycling.

[Integral](#) (automatic reset) - slowly adjusts the position of the Proportional Band (range of power output) to eliminate offset error.

[Loop Break](#) - a condition where the input is not changing or responding properly to the output action. This could be caused by a thermocouple or

Glossary

input failure, or a heater or load failure.

Loop Break Time - the time interval from when the controller detects a loop break condition and the initiation of the failsafe state.

Lowest Reading - records the lowest process value read by the controller. May be reset to zero by using the Raise or Lower arrow keys.

Lower Setpoint Limit - prohibits users from adjusting the setpoint lower than the selected value.

Manual Reset - an adjustment that moves the Proportional Band up or down by a fixed percentage so that more or less power is applied at setpoint. It is used to eliminate offset error.

On/Off Output Type - In a heating application, the controller applies 100% output power if the process temperature is below the setpoint and 0% at the setpoint. For a cooling application, the controller applies 100% output power if the process temperature is above the setpoint and 0% output power at the setpoint. There are only two output states: fully on and fully off.

Applications for On/Off Control:

1. When temperature oscillation is acceptable.
2. When constant cycling of mechanical devices is prohibited (Compressors, Blowers, etc.)
3. Under-powered processes

Output Low Limit % - Prohibits the controller's output from going below the specified percentage.

Output High Limit % - Prohibits the controller's output from going above the specified percentage.

PID Output Type (Proportional - Integral - Derivative) - The controller modulates output power by adjusting the output power percentage within a proportional band. Power is proportionally reduced as the process temperature gets closer to the setpoint temperature. PID control helps reduce overshoot on start-up, enhances stability, and compensates for process lag. The PID parameters are automatically calculated for a particular application during the autotune procedure.

Applications for PID Control:

1. Where process temperature lags exist
2. When load changes are present
3. When overshoot is prohibited
4. When very accurate control is required

Proportional Band - the band (expressed in degrees of temperature) in which the controller modulates its power percentage.

Temperature Lag - The product of thermal resistance and thermal capacity. Also defined as delay of the transmission of heat from the controlled element to the sensor caused by thermal mass of the process material and/or process container, or the distance between the control element and the sensor.

Upper Setpoint Limit - prohibits users from adjusting the setpoint higher than the selected value.

Quick Setup Instructions - Series 16C Temperature Controller

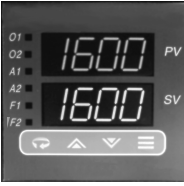

Experienced users, already familiar with the Series 16C, and using the controller with PID outputs, may follow these condensed instructions to autotune the controller and get started quickly once the instrument is properly mounted and wired, and the Security Level is set to **LnP9**. Once setup is complete, we recommend changing the Security Level back to the most restrictive level suitable for your application.

These quick setup instructions are not meant as a substitute for reading the full instruction manual supplied with the controller. Please be sure to read through the manual for specific details of operation and, most importantly, for safety precautions. If you have any questions, or experience problems with setting up your controller, consult the full instruction manual first and, if you still need assistance, contact your Athena representative or call 1-800-782-6776.



Menu Access



Raise



Lower



Mode/Enter

- Apply power. After self-check display stops, place controller in Standby mode by pressing and holding the Mode/Enter **≡** key for 3 seconds, the **▲** or **▼** key until **StBY** appears, and then the **≡** key again. **StBY** will flash, alternating with the Process Value.
 - Press and hold the Menu Access **↻** key for 3 seconds until **LnP** is displayed. Press **≡** key once until **SEPB** appears, then use **▲** or **▼** keys to select sensor input type.
 - Press **↻** to display **OUtP**. Then press **≡** once to display **OLtY**. Use **▲** or **▼** to select **Pid**.
 - Press the **≡** key until Output 1 Action **OLRC** is displayed. Select the desired output action using the **▲** or **▼** keys. (Reverse = Heating)
 - Press **≡** again to display the Output 1 Cycle Time **OLcY** parameter. Select the desired cycle time according to the output device used. If unsure, refer to the ordering code on page 52 of the instruction manual and compare it to the number on the label.
Recommended cycle times are:

For Control Output Device —	Select Cycle Time (in seconds)
B	15 to 120
E	0.2
F	0.2
G	0.2
S	0.2
T	15 to 120
Y	15 to 120
- IMPORTANT: IF ONLY ONE OUTPUT IS PID, SET THE OTHER OUTPUT TO EITHER ON/OFF, ALARM, OR OFF.**
- Press the **≡** key to display the next output parameter, and select the desired value using the **▲** or **▼** keys.
 - Press **≡** to select other Output Type following steps 4 to 6.
 - Press the **↻** repeatedly until **LunE** is displayed, then press **≡** and make sure autotune damping parameter is set to the proper setting for your application. See page 37 for more information.
 - Press and hold **↻** key for approximately 3 seconds until upper display flashes **StBY** and Process Value.
 - Press the **▲** or **▼** keys adjust setpoint to desired value.
 - Press and hold **≡** key for 3 seconds. Lower display will indicate **StBY**. Press **▲** or **▼** key until **Autun** is displayed. Press **≡** to initiate autotuning. Display will flash **LunE**. After autotune is complete, the display stops flashing, and the controller will revert to Process Value display and begin controlling the process.
 - If unacceptable overshoot occurs, change damping setting to high **Hd**, or if response is sluggish, change damping setting to low **Lo**.



Keep This Information in a Safe Place Configured Parameters Reference Data

Series C Temperature Controllers

Model Number _____

Zone Location _____

Firmware Version No. _____

(Displayed when the controller is powered up after all the segments on both lines of the display have been tested.)

Dear Customer:

Please keep this information handy – in case your controller should lose its configured initial parameter values or for easy reference when setting up a new controller.

After auto-tuning, and when your controller is controlling well, we suggest you write the displayed value for each of the menu parameters listed below. If you do not use a listed parameter, indicate "N/A". Using this information to document your parameter settings could reduce your downtime. If you have any questions, or need further assistance, please contact Athena Controls Technical Support:

Toll-free (in USA): 800.782.6776

Telephone: 610.828.2490

Fax: 610.828.7084

E-Mail: techsupport@athenacontrols.com

Website: athenacontrols.com

Configured Parameters Reference Data Series C Temperature Controllers

<u>InP</u>	<u>OUTP</u>	<u>Ctrl</u>	<u>ALr.</u>
tYPPE _____	0 1tY _____	02tY _____	db.1 _____
b 1RS _____	0 1Rc _____	02Rc _____	H45.1 _____
SCLL _____	0 1cY _____	02cY _____	db.2 _____
SCLH _____	0 1LL _____	02LL _____	H45.2 _____
SPLL _____	0 1HL _____	02HL _____	Pb.1 _____
SPHL _____	0 1RA _____	02RA _____	Pb.2 _____
IF IL _____	0 1RD _____	02RD _____	dEr _____
Options _____	0 1dL _____	02dL _____	OFF5 _____
_____	0 11H _____	02.1H _____	_____
_____	0 1SP _____	02.SP _____	_____
_____	_____	_____	A2.1H _____
_____	_____	_____	A2.SP _____

*For Toll-Free Technical Assistance in the USA,
Call Toll Free: 1-800-782-6776*



Athena Controls, Inc.
5145 Campus Drive
Plymouth Meeting, PA 19462 U.S.A.
Tel: (610) 828-2490
Fax: (610) 828-7084
Toll-Free in U.S.: 1-800-782-6776
Internet: www.athenacontrols.com