

JB9000

Junction box for use with electric heat tracing systems

JUNCTION BOX

- Available for use in safe and hazardous areas
- SIRA ATEX certified
- All boxes suitable for use with all styles of heating cable
- Complete range of boxes & terminals
- Manufactured in accordance with:
EN 50014: 1997 (A1 and A2)
EN 50019: 2000
EN 50281-1-1: 1998 + Amendment 1
- IP66 rated

INTRODUCTION

ProTherm supplies quality junction boxes only as part as a complete Heat Trace System. As standard, robust and corrosion resistant polyamide enclosures are supplied for use in safe (non-hazardous) or hazardous (Zone 1, or Zone 2) areas.

When used in hazardous areas the enclosures provide type EExe protection (increased safety) as per BS EN 50019: 2000, Electrical apparatus for potentially explosive atmospheres. Increased safety "e".

The boxes, as part of the overall Heat Trace System, also meet the requirements of IEC62395 – Electric Heat Tracing for Safe Industrial Locations and IEC60079-30 – Electric Heat Tracing for Hazardous Locations (formerly IEC62086).



SPECIFICATION

AMBIENT TEMPERATURE -40°C to +50°C
(-40°F to +122°F)

MINIMUM OPERATING TEMPERATURE -65°C* (-85°F)

EARTH CONTINUITY PLATE Available as extra

ENTRIES

Standard entries are 20mm and 25mm ISO metric.
Alternatives upon request are: ¾" and 1" B.S. Conduit,
Pg11, 13.5, 16 and 21, ½" and ¾" N.P.T.

TERMINAL BLOCKS

Weidmuller - Klippon Terminals

TYPE	WIRE CAPACITY mm ²		MAXIMUM RATINGS		
	MIN	MAX	VOLTS	AMPS	QTY
SAK2.5	0.5	2.5	550	15	10
SAK4	0.5	4.0	550	15	8
SAK6N	0.5	6.0	550	18	6
SAK10	2.5	10	550	37	4
WDU2.5	0.22	2.5	726	15	8
BK3-BK8	0.5	4.0	275	21	1
MK6/3-4-6	0.5	6.0	418	18	1

Entrelec Terminals

TYPE	WIRE CAPACITY mm ²		MAXIMUM RATINGS		
	MIN	MAX	VOLTS	AMPS	QTY
MA2.5/5	0	2.5	380	15	10
M4/6	0	4.0	660	30	8

APPROVAL DETAILS

Testing Authority Certificate No.





ATEX  Sira 03ATEX3398
Sira 03ATEX3582U

EAC*  TC RU C-GB.ГБ05.B.00191

FM  3039985

APPROX VOLUME 635cm³

WEIGHT 0.6kgs

		20mm	25mm
1 Way		9001	9051
2 Way		9002	9052
3 Way		9003	9053
4 Way		9004	9054
Angle		9005	9055

To order Enclosures with alternative entries, please give full description of requirements.

DIMENSIONS

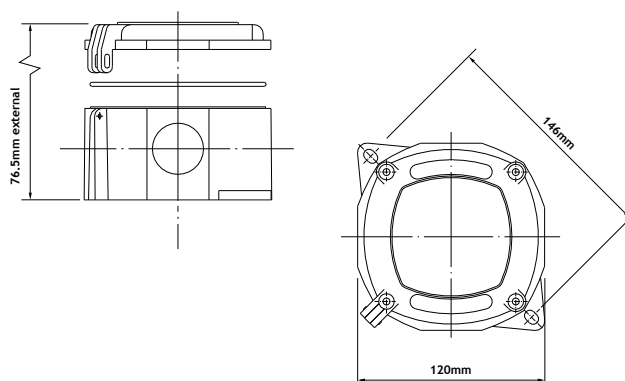

MATERIAL Glass reinforced Polyester,
Fire Retardant

FINISH Matt Black

SPECIAL FEATURE

The enclosure has a uniquely designed hinged cover that allows the unit to remain 'as one' during installation.

"T" RATINGS

The maximum current allowed per terminal way is limited to 26A for a temperature classification of T4 and 16A for a temperature classification of T6. During installation the engineer must apply the relevant T Class to the certification label.

Please refer to product instructions for more information.